

LESS LAND OCCUPATION, MORE SPACE

更小占地，更大空间

 结构紧凑
Compact Structure

 创新设计
Innovative Design

 智能系统
Intelligent System

 智能安装
Intelligent Installation

 灵巧主机
Flexible Traction Machine

 卓越空间
Remarkable Space

在方寸空间内游刃有余，
以定制化家用电梯解决方案，
释放空间智慧，
赋予生活更多舒适感。

Easily releases the wisdom of space and
Creates a more comfortable life
By offering custom-made home elevators
In a small space.

匠心独运，铸就信赖

EXQUISITE CRAFTSMANSHIP BUILD TRUST

航空漆饰

井道漆面采用航天航空的特种材料和多重制作工艺，具备其他材料工艺难以企及的高强度抗氧化、抗腐效果，并实现轻量级的盈薄与高强度耐热耐油，在一定程度上既确保了表层的工艺美观性，同时提升了电梯的使用寿命。

Aerospace paint

Special aerospace materials and multiple production technologies are used for well paint, and are much better in terms of oxidation and corrosion resistance compared with other materials and technologies. Moreover, the well paint is light and good in heat and oil resistance. Therefore, to some extent, it ensures the beauty of surface while increasing the service lives of elevators.

军工级型材

采用军工级铝合金材质，在减轻传统电梯钢板型材自身重量的基础上，优化整体框架的强度，使电梯在不增加能耗的同时，推动轿厢框架工艺模块化，提升整体美感。

Military materials

The military-grade aluminum alloy material is used to optimize the overall frame strength on the basis of reducing the weight of traditional elevator steel plates. So, without increasing the energy consumption of elevators, Sanyo Elevator promoted the modular production of car frames and enhanced the overall beauty.

井道框架 Shaft frame



香槟银
框架井道1



深空灰
框架井道2



磨砂白
框架井道3



磨砂黑
框架井道4



普鲁士蓝
框架井道5



咖棕色
框架井道6

玻璃材质 Glass material



全透明玻璃
Fully transparent glass

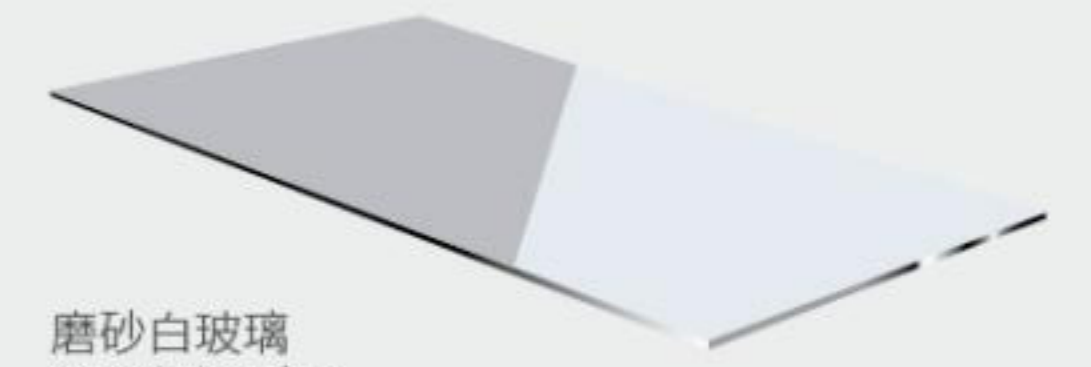

磨砂白玻璃
Frosted white glass

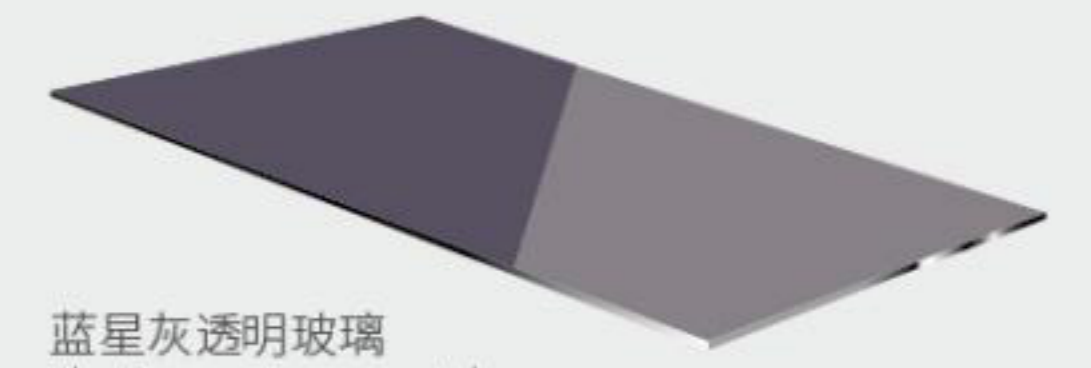

蓝星灰透明玻璃
Blue Star grey transparent glass

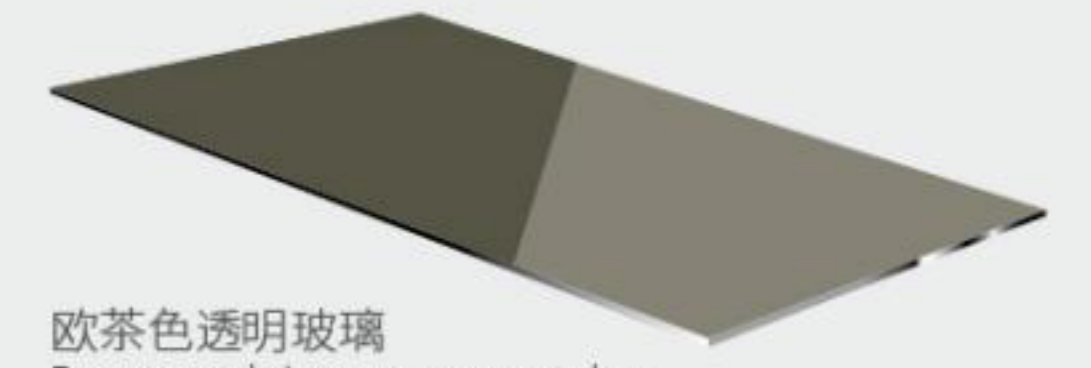

欧茶色透明玻璃
European style brown transparent glass

智慧生活，创享非凡

SMART LIFE

CREATING EXTRAORDINARY

ENJOYMENTS



30%

井道空间利用率提升
The utilization rate of well
space increases by 30%

智能维保

制定专属维保方案，通过数字系统提供预先性和主动性维保服务，让数字未来真正服务家居安全。

Intelligent maintenance

It makes exclusive plans for maintenance and offers active maintenance services in advance by a digital system to truly ensure home safety by digital technology.

智能物联平台

实时监测电梯的参数及运行状态，故障自检，意外分析，保障电梯运行，杜绝意外发生，且一部智能手机就能满足操作。

Intelligent iot platform

It monitors parameters and running states of elevators in real time. It ensures elevator operation and eliminates accidents through fault self-inspection and accident analysis. Moreover, users can operate it just by a smart phone.

智能呼梯

提供指纹识别、人脸识别、手势识别、小程序呼梯等交互功能，反馈迅速，带来高效省心的体验。

Intelligent call

It provides many interactive functions, such as fingerprint recognition, face recognition, gesture recognition and calling elevators by applet. Rapid responses ensure efficient comfortable experiences.

智能安全系统

实现困人自动语音警报，电梯内设置一键呼救功能，确保最快速度完成救援。配备ARD应急救援，如遇停电故障可保证能够平层开门。

Intelligent safety system

The voice alarm is sounded automatically when passengers are trapped in elevators. The one-click emergency call function in the elevator ensure the rapidest rescue. The ARD emergency rescue ensures the levelling and door opening of elevators in case of power failure.



安装革命，技术创新
INSTALLATION REVOLUTION
TECHNOLOGICAL INNOVATION

更便捷

模块化系统不止于安装阶段，如后期需要拆装、更换电梯装潢，也快捷便利，且成本低。

More convenient

In addition to more convenient installation, it ensues rapid, convenient, low-cost disassembly and replacement of decoration later.

更安全

安装现场“无尘无焊接”，规避了现场操作的各种安全隐患，同时最大限度保持用户家居空间的清洁安静。

Safer

Dust-free and welding-free installation sites avoid various hidden perils caused by field operation while keeping users' houses clean and quiet to the greatest extent possible.

模块化

独创的模块化系统，可以通过在不同组件设定不同的功能，把一个问题分解成多个小的独立、互相作用的组件。

Modular

creative modular system resolves a complicate management system into better manageable modules. It can resolve a problem into multiple small independent interactive modules by setting different modules with different functions to handle complicate large elevator structures.

智能化

轿厢各模块可智能化安装与拆卸，实现效率最大化，以创新科技打造家的智慧时尚。

Intelligent

All modules of cars can be installed and dismantled intelligently to maximize efficiency to build smart fashionable homes by innovative technologies.

全力以赴 守护安全

GIVE IT YOUR ALL GUARDING SECURITY

品质护航

坚固的电梯结构，严选高品质安全部件，配置周全的安全防护系统，全方位守护家人安全。

High Quality

With a solid structure, carefully selected quality safety components and an excellent safety protection system, it safeguards the safety of your family in an all-round way.

随心操作

操作面板优化升级，外形时尚美观，使用便捷，指尖体验更出色。

User-friendly

The operating panel is optimized and upgraded so it is stylish, beautiful, convenient and more user-friendly.

优化空间

最高空间利用率带来更大的轿厢空间，高颜值、大空间，乘梯更舒适。

Optimized Space

The maximized space utilization brings a large car space. The attractive and large car space ensures better experiences for passengers.



静音平缓

采用最佳零部件和最合理的结构设计方案，优越的减震降噪技术，上下运行静音平缓，舒适自然。

Silent and Smooth

The best parts, more reasonable structural designs and excellent shock-absorbing and noise-reducing. Therefore, elevators can move up and down silently and smoothly, offering comfortable and natural experiences.

钢带方案

STEEL STRIP SCHEME

以复合钢带作为传动介质，更加环保舒适，且运行平稳，恒久高效，同时降低顶层高度及地坑深度的要求。

With the composite steel belt as the transmission medium, it is more friendly and comfortable, and has stable operation, permanent and efficient, while reducing the requirements of the top floor height and pit depth.

DS300

- 钢带1:1 / 2:1
- 封闭井道
- 钣金轿厢
- Steel strip 1:1/2:1
- Closed shaft
- Sheet metal elevator car

DS300G

- 钢带1:1 / 2:1
- 观光井道
- 钣金轿厢
- Steel strip 1:1/2:1
- Sightseeing shaft
- Sheet metal elevator car

DS800

- 钢带1:1 / 2:1
- 观光井道
- 铝合金轿厢
- Steel strip 1:1/2:1
- Sightseeing shaft
- Aluminum alloy elevator car

DS1000

- 钢带2:1
- 观光井道
- 铝合金轿厢
- 曳引对重平衡架
- Steel strip 2:1
- Sightseeing shaft
- Aluminum alloy elevator car
- Traction counterweight balance frame



钢丝绳方案

WIRE ROPE SCHEME

曳引式驱动，高度自动化，性能卓越，运行噪音低，使用寿命长，为用户带来静谧高效的乘车体验。

Traction drive, highly automated, excellent performance, low running noise, long service life, bring a quiet and efficient ride experience for users.

DS200

- 钢丝绳2:1
- 封闭井道
- 钣金轿厢
- Wire rope scheme 1:1/2:1
- Closed shaft
- Sheet metal elevator car

DS200G

- 钢丝绳2:1
- 观光井道
- 钣金轿厢
- Wire rope scheme 1:1/2:1
- Sightseeing shaft
- Sheet metal elevator car

井道面积利用率较传统曳引式提升30%
The utilization rate of shaft area is increased by 30% compared with the traditional traction type

30%



全能姿态，助力出行

VERSATILE POSTURE HELPING WITH TRAVEL

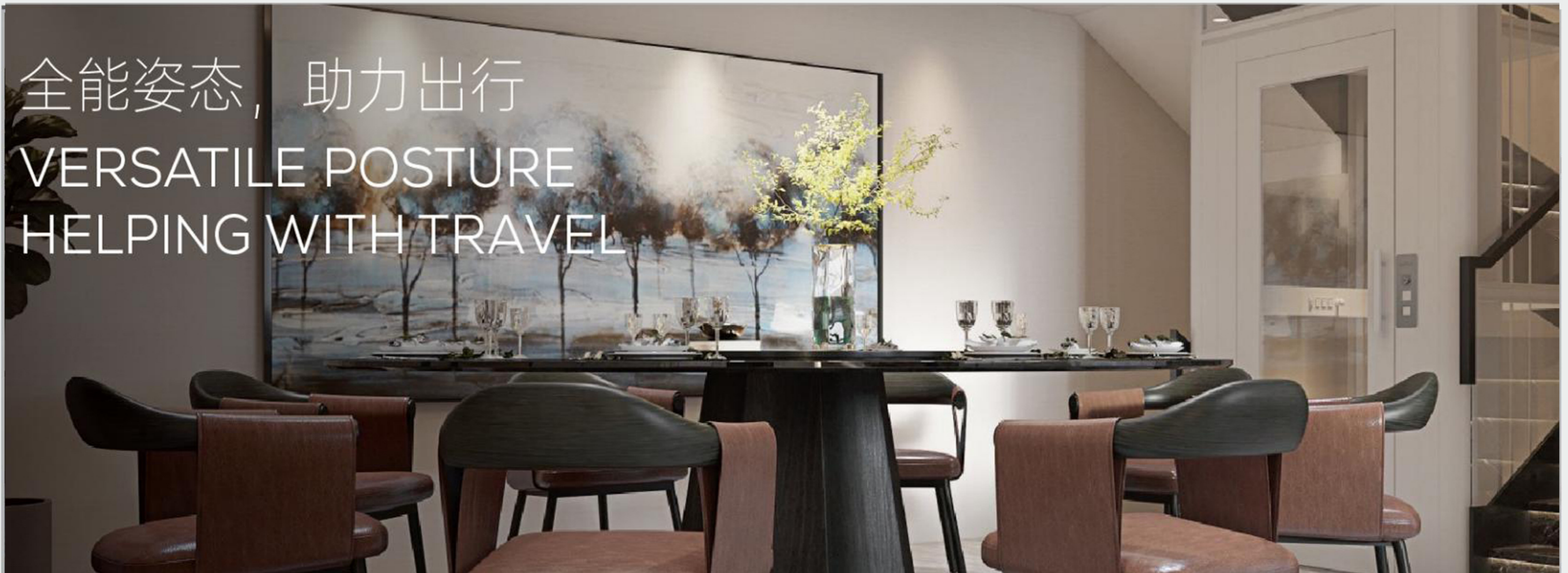

多种安装方式

Multiple installation methods

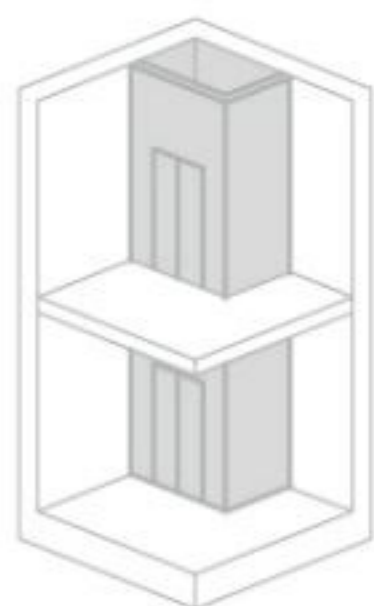

混凝土井道
Concrete Well

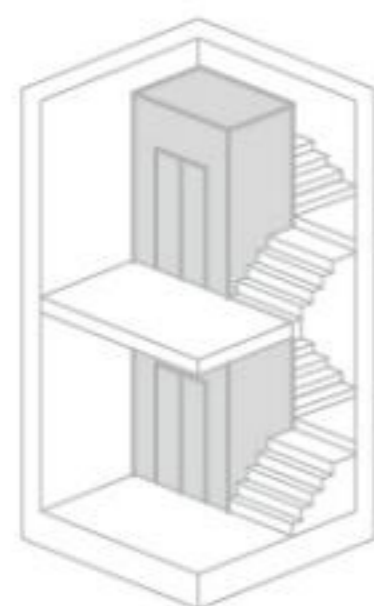

环绕楼梯中间
The Middle of Spiral Stairs

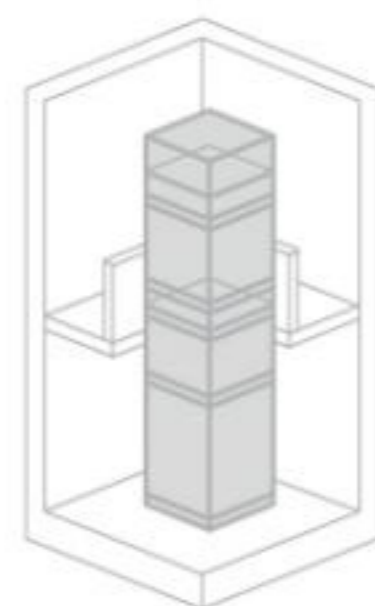

中空大厅
Hollow Hall

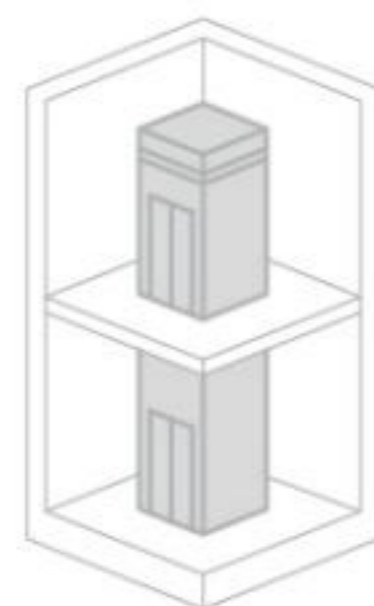

室内楼板开孔
Bore Indoor Floors

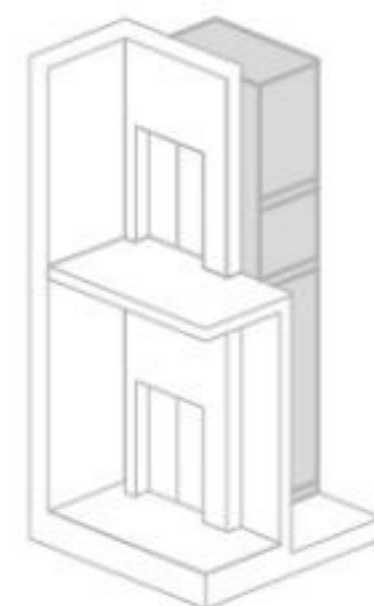

室外梯
Outdoor Stairs

- 无需建筑墙体开孔，定位简单，安装便捷
- 井道利用率高，对重位置灵活，可侧置、后置，安全可靠
- 突破空间限制的全建筑结构解决方案

- Without the need to open holes in building walls, it is easy to fix and convenient to install.
- It boasts a high ratio of well utilization and a flexible position of counterweights, which can be mounted on sides or at the rear, safe and reliable.
- It offers overall building structure solutions breaking the space limit.

全生命周期专业服务

Life-cycle Professional Services

六大特色服务

With six major signature services



前期服务能力
Early-stage service ability



快速设计服务能力
Quick design service ability



个性化设计服务能力
Personalized design service ability



智能制造能力
Intelligent manufacturing ability



快速安装维保服务能力
Quick installation and maintenance service ability



优质售后服务能力
Excellent after-sales service ability

专注为家

CONCENTRATE ON
HOME LIFTS



主流梯型全覆盖，设计不拘泥传统，灵活适配各种建筑条件，全面满足用户需求，全方位解码舒适空间。

The series covers all mainstream lift models, doesn't stick to traditional design, and can flexibly adapt to various building conditions. It can meet user requirements and create a luxury comfortable space in an all-round way.

曳引钢带对重

Traction steel belt counterweight

利用对重和轿厢的平衡原理，导轨分别位于轿厢两侧，受力均匀，运行平稳，由永磁同步无齿轮电引主机通过钢带带动轿厢上下运行。

Using the principle of balance between counterweight and elevator car, the guide rails are located on both sides of the elevator car, with uniform force and smooth operation. The elevator car is driven up and down by a permanent magnet synchronous gearless electric lead host through a steel strip.

- 市场主流梯形，方便安装维护
- 专用曳引机架，不增加建筑承重
- VVVF驱动技术，安全节能，运行平稳舒适
- The mainstream trapezoidal shape in the market is convenient for installation and maintenance
- Dedicated traction machine frame, without increasing the building's load-bearing capacity
- VVVF drive technology, safe and energy-saving, smooth and comfortable operation



曳引钢丝绳对重

Traction wire rope counterweight

利用对重和轿厢的平衡原理，导轨分别位于轿厢两侧，受力均匀，运行平稳，由永磁同步无齿轮电引主机通过钢丝绳带动轿厢上下运行。

Using the principle of balance between the counterweight and the car, the guide rails are located on both sides of the car, with uniform force and smooth operation. The car is driven up and down by a permanent magnet synchronous gearless electric lead host through a steel wire rope.

- 市场主流梯形，方便安装维护
- 专用曳引机架，不增加建筑承重
- VVVF驱动技术，安全节能，运行平稳舒适
- 钢丝绳10毫米直径的升级版高分子压实股，远高行业标准
- The mainstream trapezoidal shape in the market is convenient for installation and maintenance
- Dedicated traction machine frame, without increasing the building's load-bearing capacity
- VVVF drive technology, safe and energy-saving, smooth and comfortable operation
- Upgraded polymer compacted strand with a diameter of 10mm for steel wire rope, far exceeding industry standards



曳引钢丝绳强驱

Traction wire rope strong drive

与曳引对重梯形的唯一区别在于无对重块，通过电机带动曳引轮转动从而带动轿厢上下运行，更节省井道空间，专为空间有限的家庭设计。

The only difference from the traction counterweight trapezoid is the absence of counterweight blocks. The traction wheel is driven by a motor to rotate, thereby driving the car up and down, saving more space in the shaft. It is designed specifically for households with limited space.

- 井道面积利用率较传统曳引式提升30%
- 钢丝绳10毫米直径的升级版高分子压实股，远高行业标准
- 适用各类预留空间较小的家庭
- The utilization rate of shaft area has increased by 30% compared to traditional traction type
- Upgraded polymer compacted strand with a diameter of 10mm for steel wire rope, far exceeding industry standards
- Suitable for households with limited reserved space

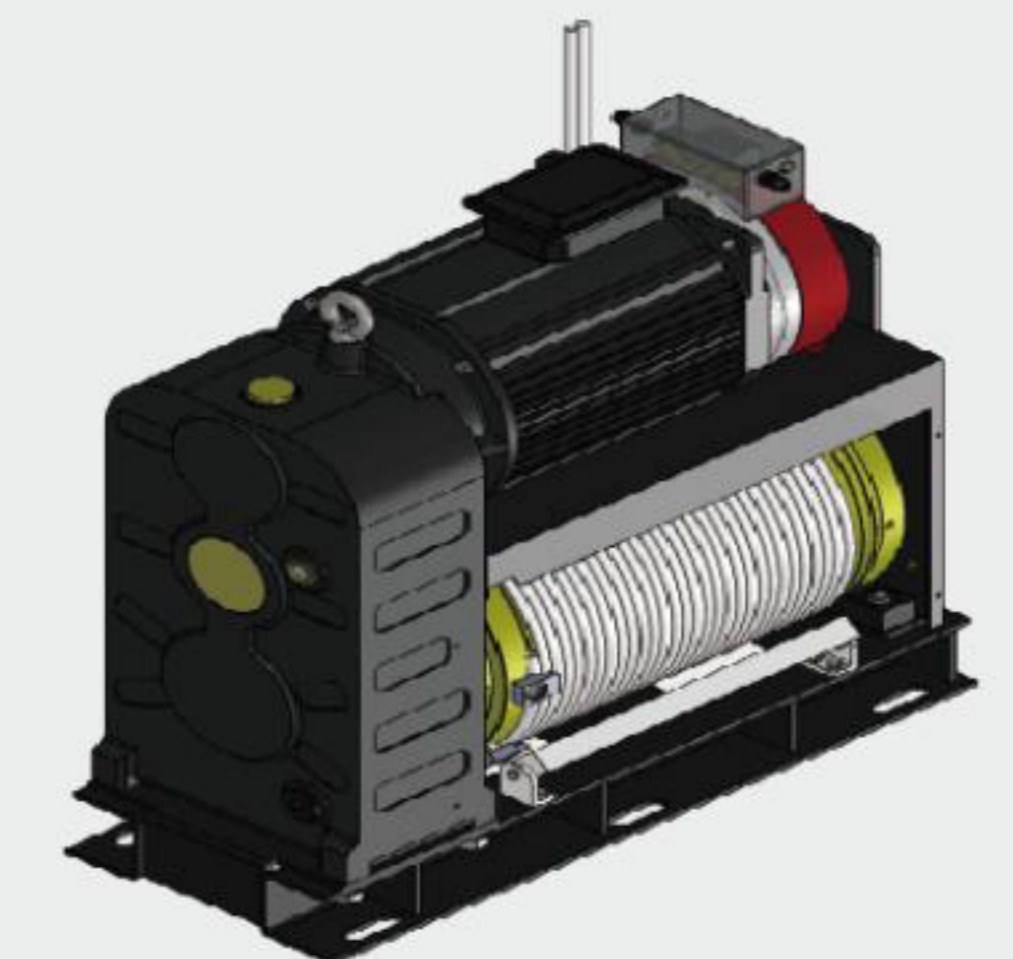

轿厢装潢 CAR DECORATION



注: 如果跨系列选择轿厢装潢, 价格会发生变动
Note: If choosing car decoration across series, the price may change

DS200 系列 series

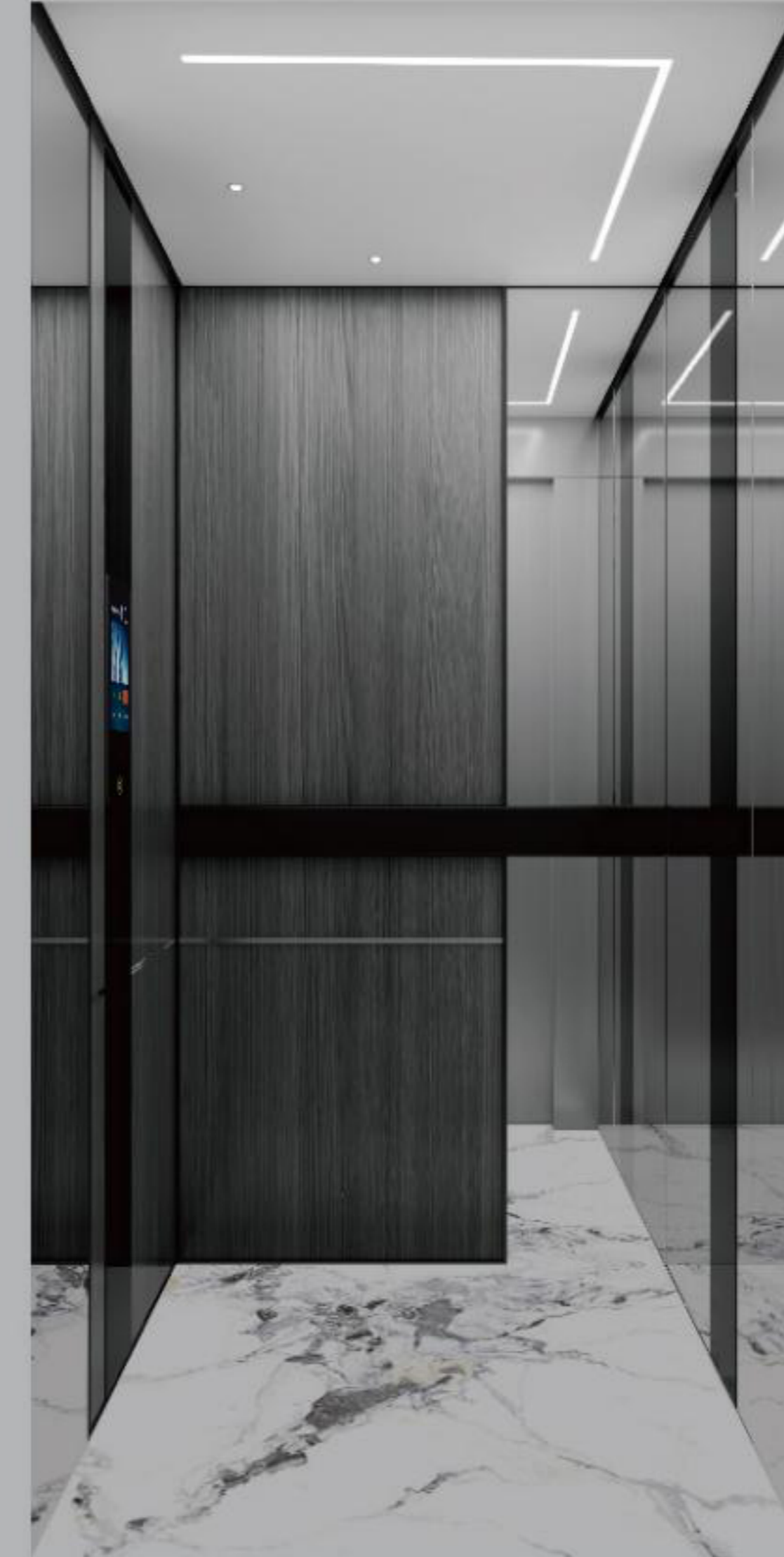

DS-V001y

免费可选 Free optional



DS-V003y

免费可选 Free optional



吊顶:高定板、LED灯带、筒灯
后壁:高定板、装饰条、镜面不锈钢
侧壁:高定板、镜面不锈钢、黑钛发纹不锈钢
扶手:黑色榉木
地板:高端岩板

Ceiling:
High ceiling panel, LED light strip, tube light
Posterior wall:
High ceiling panel, decorative strip, mirror stainless steel
Side wall:
High ceiling panel, mirror stainless steel, black titanium
hairline stainless steel
Handrail: Black beech
Floor: High end rock slab

吊顶:高定板、LED灯带、筒灯
后壁:高定板、镜面不锈钢、LED灯带
侧壁:镜面不锈钢、高定板、LED灯带、黑钛发纹不锈钢
扶手:黑色榉木
地板:高端岩板

Ceiling:
High ceiling panel, LED light strip, tube light
Posterior wall:
High ceiling panel, mirror stainless steel, LED light strip
Side wall:
Mirror stainless steel, high ceiling panel, LED light strip, black
titanium hairline stainless steel
Handrail: Black beech
Floor: High end rock slab

DS200 系列

series



DS-V057

免费可选 Free optional



吊顶:发纹不锈钢、线型灯
后壁:发纹不锈钢、线型灯、镜面不锈钢
侧壁:发纹不锈钢、黑钛发纹不锈钢
地板:高端岩板

Ceiling:
Hairline stainless steel, linear light
Posterior wall:
Hairline stainless steel, linear lamp, mirror stainless steel
Side wall:
Hairline stainless steel, black titanium hairline stainless steel
Floor: High end rock slab



DS-V077b

免费可选 Free optional



吊顶:亚克力板、LED、黑钛发纹不锈钢
后壁:枪灰喷砂不锈钢、暗藏灯带、黑钛发纹不锈钢
侧壁:枪灰喷砂不锈钢、黑钛装饰条
地板:天然大理石

Ceiling:
Acrylic board LED, black titanium hairline stainless steel
Posterior wall:
Gun gray sandblasted stainless steel, hidden light strip, black titanium hairline stainless steel
Side wall:
Gun gray sandblasted stainless steel, black titanium decorative strip
Floor: Natural marble

DS200 系列

series



DS-V081

免费可选 Free optional



吊顶:高定板、线型灯、筒灯
后壁:高定板、线型灯
侧壁:高定板、镜面不锈钢
地板:高端岩板

Ceiling:
High ceiling panel, linear light, tube light
Posterior wall:
High ceiling panel, linear light
Side wall:
High ceiling panel, mirror stainless steel
Floor: High end rock slab



DS-V105

免费可选 Free optional



吊顶:黑钛镜面不锈钢、筒灯、暗藏灯带
后壁:黑钛镜面不锈钢、暗藏灯带、艺术钢板
侧壁:黑钛镜面不锈钢、艺术钢板
地板:天然大理石

Ceiling:
Black titanium mirror stainless steel, tube light, concealed light strip
Posterior wall:
black titanium mirror stainless steel, hidden light strip, artistic steel plate
Side wall:
Black Titanium Mirror Stainless Steel, Art Steel Plate
Floor: Natural marble

DS200 系列 series



DS-V106

免费可选 Free optional



DS-V107

免费可选 Free optional



DS200G/300G/800 系列 series



DS-G016b

免费可选 Free optional



DS-G050

免费可选 Free optional



吊顶:亚克力板、LED灯、筒灯
后壁:艺术钢板、黑钛装饰条
侧壁:艺术钢板、黑钛装饰条
地板:高端岩板

Ceiling:
Acrylic board, LED lights, tube lights

Posterior wall:
Art steel plate, black titanium decorative strip

Side wall:
Art steel plate, black titanium decorative strip

Floor: High end rock slab

吊顶:高定板、筒灯、暗藏灯带
后壁:艺术钢板、镜面不锈钢
侧壁:艺术钢板、黑钛装饰条
地板:高端岩板

Ceiling:
High ceiling panel, tube light, concealed light strip

Posterior wall:
Art steel plate, mirror stainless steel

Side wall:
Art steel plate, black titanium decorative strip

Floor: High end rock slab

吊顶:泡沫铝、高定板、隐藏灯带
后壁:蓝星灰玻璃
侧壁:蓝星灰玻璃、高定板
地板:天然大理石

Ceiling:
Oam aluminum, high ceiling panel, hidden light strip

Posterior wall:
Blue star gray glass

Side wall:
Blue star gray glass, high fixed panel

Floor: Natural marble

吊顶:星空顶、线型灯、暗藏灯带
后壁:蓝星灰玻璃
侧壁:蓝星灰玻璃、黑钛镜面不锈钢、高定板
地板:高端岩板

Ceiling:
Starry sky ceiling, linear lights, hidden light strip

Posterior wall:
Blue star gray glass

Side wall:
Blue star grey glass, black titanium mirror stainless steel, high ceiling panel

Floor: High end rock slab

DS200G/300G/800 系列 series



DS-G056

免费可选 Free optional



DS-G060

免费可选 Free optional



DS200G/300G/800 系列 series



DS-G062

免费可选 Free optional



DS-G063

免费可选 Free optional



吊顶:高定板、暗藏灯带

后壁:蓝星灰玻璃

侧壁:蓝星灰玻璃、香槟金镜面不锈钢

地板:天然大理石

Ceiling:
High ceiling panel, concealed light strip

Posterior wall:
Blue star gray glass

Side wall:
Blue star grey glass, champagne gold mirror stainless steel

Floor: Natural marble

吊顶:星空顶、线型灯、暗藏灯带

后壁:蓝星灰玻璃

侧壁:蓝星灰玻璃、黑钛镜面不锈钢、高定板

地板:高端岩板

Ceiling:
Starry sky ceiling, linear lights, hidden light strip

Posterior wall:
Blue star gray glass

Side wall:
Blue star grey glass, black titanium mirror stainless steel, high ceiling panel

Floor: High end rock slab

吊顶:高定板、线型灯、筒灯

后壁:透明白玻

侧壁:透明白玻、高定板

地板:天然大理石

Ceiling:
High ceiling panel, linear light, tube light

Posterior wall:
Transparent white glass

Side wall:
Transparent white glass, high ceiling panel

Floor: Natural marble

吊顶:高定板、线型灯、筒灯

后壁:透明白玻

侧壁:透明白玻、高定板

地板:天然大理石

Ceiling:
High ceiling panel, linear light, tube light

Posterior wall:
Transparent white glass

Side wall:
Transparent white glass, high ceiling panel

Floor: Natural marble

DS200G/300G/800 系列 series



DS-G065

免费可选 Free optional



DS-G067

免费可选 Free optional



DS300 系列 series



DS-V033

免费可选 Free optional



DS-V037

免费可选 Free optional



吊顶:亚克力板、LED灯
后壁:透明白玻
侧壁:透明白玻、高定板
地板:天然大理石
Ceiling: Acrylic board, LED light
Posterior wall: Transparent white glass
Side wall: Transparent white glass, high ceiling panel
Floor: Natural marble

吊顶:亚克力板、LED灯
后壁:透明白玻
侧壁:透明白玻、香槟金发纹不锈钢
地板:天然大理石
Ceiling: Acrylic board, LED light
Posterior wall: Transparent white glass
Side wall: Transparent white glass, champagne gold striped stainless steel
Floor: Natural marble

吊顶:钛金镜面不锈钢、筒灯、线型灯
后壁:镜面不锈钢、钛金发纹不锈钢
侧壁:发纹不锈钢、不锈钢
地板:天然大理石
Ceiling: Titanium mirror stainless steel, tube lights, linear lights
Posterior wall: Mirror stainless steel, titanium gold patterned stainless steel
Side wall: Hairline stainless steel, stainless steel
Floor: Natural marble

吊顶:星空顶,线型灯
后壁:镜面不锈钢, 香槟金发纹不锈钢, 线型灯
侧壁:镜面不锈钢, 香槟金发纹不锈钢
地板:天然大理石
Ceiling: Starry sky ceiling, linear lights
Posterior wall: Mirror stainless steel, champagne gold patterned stainless steel, linear light
Side wall: Mirror stainless steel, champagne gold patterned stainless steel
Floor: Natural marble

DS300 系列

series



DS-V047pro

有偿可选 Paid optional



吊顶:镜面不锈钢, 高定板、射灯、暗藏灯带
后壁:高定板(拼纹)、古铜镜面不锈钢、暗藏灯带
侧壁:高定板、黑钛不锈钢装饰条、暗藏灯带
地板:天然大理石

Ceiling: Mirror stainless steel, high ceiling panel, spotlights, concealed light strips

Posterior wall: High ceiling panel (patchwork), antique bronze mirror stainless steel, hidden light strip

Side wall: High ceiling panel, black titanium stainless steel decorative strip, hidden light strip

Floor: Natural marble



DS-V072

免费可选 Free optional



吊顶:高定板、暗藏灯带、玫瑰金水波纹
后壁:高定板、暗藏灯带、艺术钢板
侧壁:高定板、艺术钢板
地板:水磨石

Ceiling: High ceiling panel, concealed light strip, rose gold water ripple

Posterior wall: High ceiling panel, hidden light strip, artistic steel plate

Side wall: High ceiling panel, artistic steel plate

Floor: Terrazzo

DS300 系列

series



DS-V083

免费可选 Free optional



吊顶:高定板、线型灯、暗藏灯带
后壁:高定板、皮纹、线型灯、暗藏灯带
侧壁:高定板、皮纹、黑钛装饰条
扶手:嵌入式扶手
地板:高端岩板

Ceiling: High ceiling panel, linear lights, concealed light strips

Posterior wall: High ceiling panel, leather pattern, linear light, hidden light strip

Side wall: High ceiling panel, leather pattern, black titanium decorative strip

Handrail: Embedded handrail Floor: High end rock slab

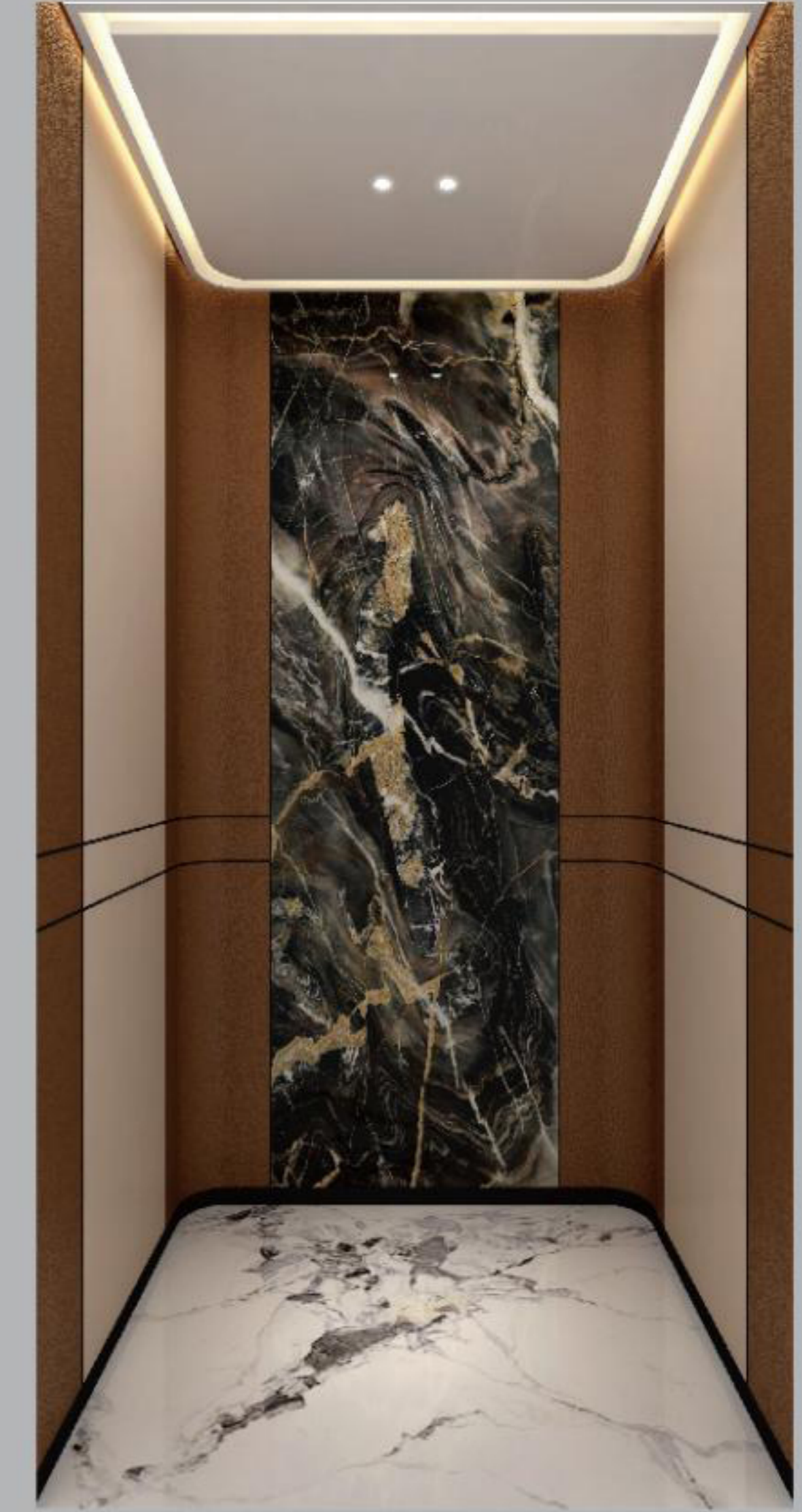

DS-V087

免费可选 Free optional



吊顶:高定板、筒灯、暗藏灯带
后壁:皮纹、岩板、黑钛装饰条
侧壁:皮纹、高定板、黑钛装饰条
地板:高端岩板

Ceiling: High ceiling panel, tube light, concealed light strip

Posterior wall: Leather grain, rock slab, black titanium decorative strip

Side wall: Leather grain, high ceiling panel, black titanium decorative strip

Floor: High end rock slab

DS300 系列 series



DS-V099

免费可选 Free optional



吊顶:亚克力板、LED灯
后壁:大理石、黑钛装饰条暗藏灯带、黑钛镜面不锈钢
侧壁:艺术钢板、黑钛装饰条
地板:天然大理石

Ceiling:
Acrylic board, LED lights

Posterior wall:
Marble, black titanium decorative strip with hidden light strip, black titanium mirror stainless steel

Side wall:
Art steel plate, black titanium decorative strip

Floor: Natural marble



DS-V102

免费可选 Free optional



吊顶:高定板、筒灯、暗藏灯带
后壁:高定板、暗藏灯带、艺术钢板、黑钛装饰条
侧壁:高定板、艺术钢板、暗藏灯带
扶手:皮纹扶手
地板:大理石

Ceiling:
High ceiling panel, tube light, concealed light strip

Posterior wall:
High ceiling panel, hidden light strip, artistic steel plate, black titanium decorative strip

Side wall:
high fixed plate, artistic steel plate, hidden light strip

Handrail: Leather patterned handrail Floor: Marble

DS300 系列 series



DS-V108

免费可选 Free optional



吊顶:星空顶、线型灯、暗藏灯带
后壁:艺术钢板、暗藏灯带
侧壁:镜面不锈钢、艺术钢板
地板:大理石

Ceiling:
Starry sky ceiling, linear lights, hidden light strip

Posterior wall:
Artistic steel plate, hidden light strip

Side wall:
Mirror stainless steel, artistic steel plate

Floor: Marble



DS-V109

免费可选 Free optional



吊顶:千层镜、暗藏灯带
后壁:枪灰喷砂不锈钢、暗藏灯带、镜面不锈钢
侧壁:枪灰喷砂不锈钢、镜面不锈钢
地板:高端岩板

Ceiling:
Thousand layer mirror, hidden light strip

Posterior wall:
Gun ash sandblasted stainless steel, concealed light strip, mirror stainless steel

Side wall:
Gun grey sandblasting stainless steel, mirror stainless steel

Floor: High end rock slab

DS1000 系列 series



DS-G036

免费可选 Free optional



吊顶:碳晶板
后壁:高端岩板
侧壁:透明白玻
地板:高端岩板

Ceiling:
Carbon crystal board

Posterior wall:
High-end rock slab

Side wall:
Transparent white glass

Floor: High end rock slab



DS-G037

免费可选 Free optional



吊顶:发纹不锈钢
后壁:艺术玻璃
侧壁:透明白玻
地板:天然大理石

Ceiling:
Hairline stainless steel

Posterior wall:
Art glass

Side wall:
Transparent white glass

Floor: High end rock slab

DS1000 系列 series



DS-G038

免费可选 Free optional



吊顶:碳晶板
后壁:艺术玻璃
侧壁:透明白玻
地板:高端岩板

Ceiling:
Carbon crystal board

Posterior wall:
Art glass

Side wall:
Transparent white glass

Floor: High end rock slab



DS-G039

免费可选 Free optional



吊顶:碳晶板
后壁:高端岩板
侧壁:透明白玻
地板:高端岩板

Ceiling:
Carbon crystal board

Posterior wall:
High end rock slab

Side wall:
Transparent white glass

Floor: High end rock slab

DS1000 系列

series



DS-G044

免费可选 Free optional



DS-G045

免费可选 Free optional



DS1000 系列

series



DS-G046

免费可选 Free optional



DS-G047

免费可选 Free optional



吊顶:黑钛发纹不锈钢

后壁:拉丝玻璃

侧壁:透明白玻

地板:编制纹PVC

Ceiling:
Black titanium hairline stainless steel

Posterior wall:
Brushed glass

Side wall:
Transparent white glass

Floor: Woven pattern PVC

吊顶:发纹不锈钢

后壁:高端岩板

侧壁:透明白玻

地板:高端岩板

Ceiling:
Hairline stainless steel

Posterior wall:
High end rock slab

Side wall:
Transparent white glass

Floor: High end rock slab

吊顶:发纹不锈钢

后壁:玫瑰金不锈钢锤纹板

侧壁:拉丝玻璃

地板:天然大理石

Ceiling:
Hairline stainless steel

Posterior wall:
Rose gold stainless steel hammer plate

Side wall:
Brushed glass

Floor: Natural marble

吊顶:碳晶板

后壁:高端岩板

侧壁:透明白玻

地板:高端岩板

Ceiling:
Carbon crystal board

Posterior wall:
High end rock slab

Side wall:
Transparent white glass

Floor: High end rock slab

轿厢内召
CAR OPERATION
PANEL

DS200/200G



DS-COP20
标配 Standard

10.1寸按键款
10.1-inch button design



DS-COP21
标配 Standard

10.1寸触摸屏
10.1-inch touch screen

DS1000



DS-COP19
标配 Standard

10.1寸触摸屏
10.1-inch touch screen

DS300/300G/800

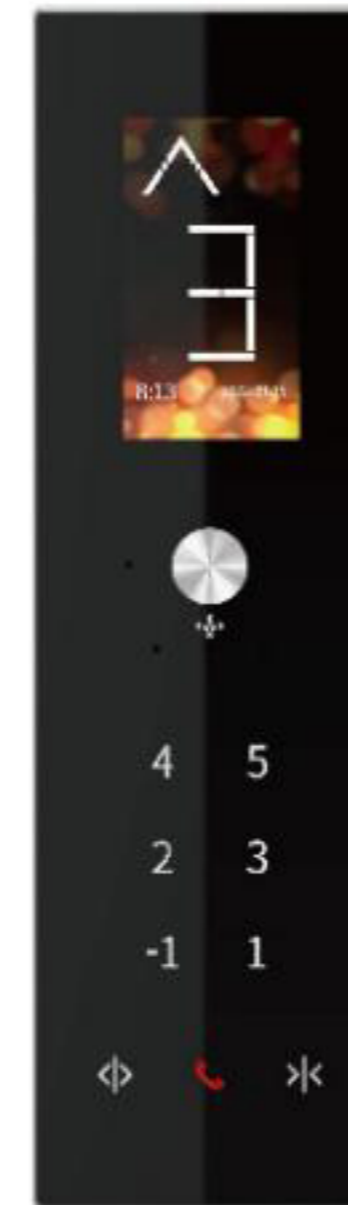

DS-COP14
标配 Standard

7寸触摸屏
7-inch touch screen

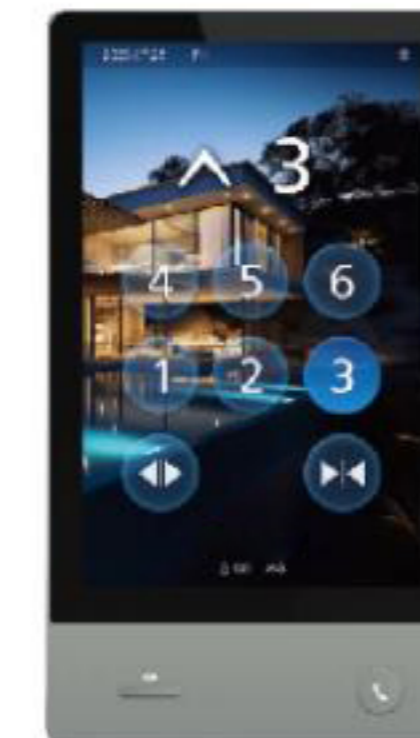

DS-COP17
标配 Standard

10.1寸触摸屏
10.1-inch touch screen



DS-COP22
标配 Standard

13.3寸触摸屏
13.3-inch touch screen



DS-COP23
标配 Standard

10.1寸触摸屏
10.1-inch touch screen

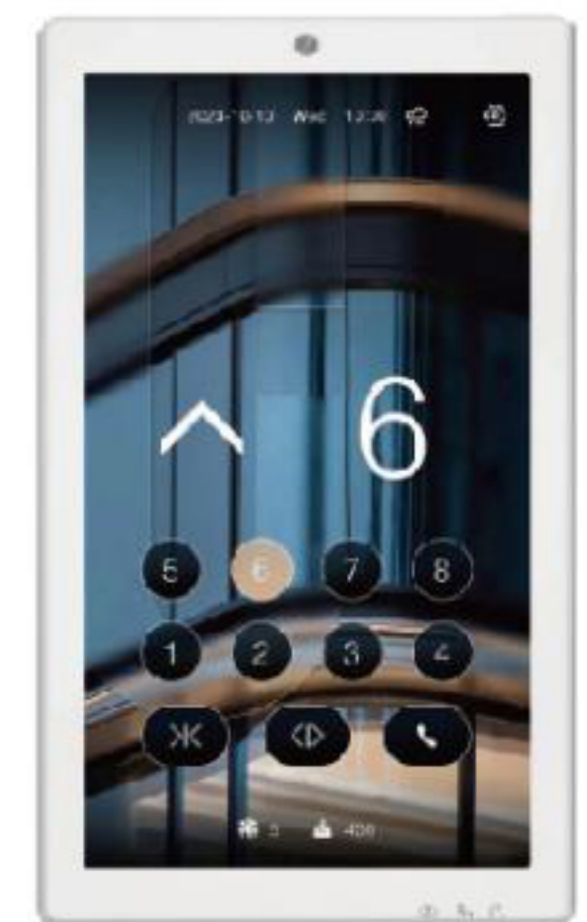

DS-COP18
有偿可选 Paid optional

13.3寸触摸屏
13.3-inch touch screen



外呼
LANDING
OPERATION PANEL

DS200/200G



DS-HB23



DS-HB24

DS300



DS-HB02



DS-HB11



DS-HB20



DS-HB16



DS-HB22

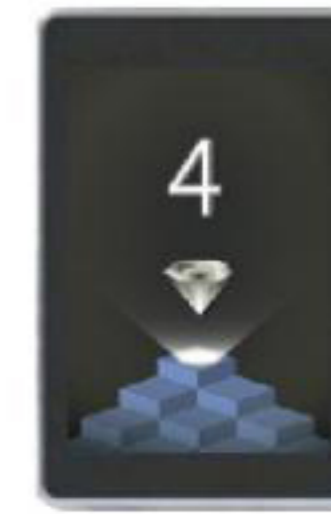

DS-HB25

DS300G/800/1000



DS-HB11



DS-HB20



DS-HB16



DS-HB17



DS-HB22



DS-HB25

厅门 LANDING DOOR



DS-TM01
选配 Optional

磨砂黑框架、
手拉门玻璃
Frosted black frame,
sliding door glass



DS-TM02
选配 Optional

香槟银框架、
中分门玻璃
Champagne silver frame,
split door glass



DS-TM09
选配 Optional

咖棕色框架、
中分双折门玻璃
Coffee brown frame,
Center split double fold door glass



DS-TM10
选配 Optional

深空灰框架、
旁开门玻璃
Deep air ash frame,
Side opening door glass

框架颜色可选
Frame color optional

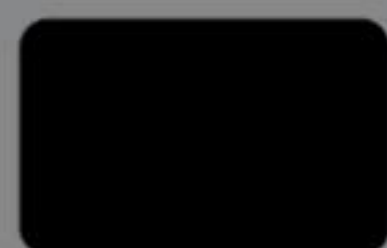

磨砂黑
Matte black



磨砂白
Frosted white



深空灰
Deep air ash

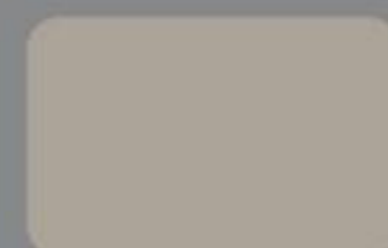

香槟银
Champagne silver



普鲁士蓝
Prussian blue

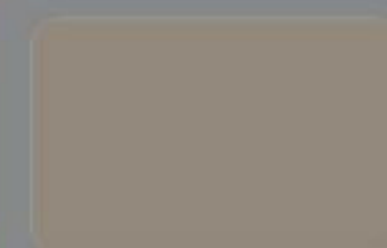

咖棕色
Coffee brown



DS-TM05
选配 Optional

发纹不锈钢
Hairline stainless
steel



DS-TM06
选配 Optional

黑钛发纹不锈钢
Black titanium hairline
stainless steel



DS-TM07
选配 Optional

钛金发纹不锈钢，蚀刻
Titanium hairline
stainless steel, etched



DS-TM08
选配 Optional

发纹不锈钢，蚀刻
Hairline stainless
steel, etched



DS-TM11
选配 Optional

钛金发纹不锈钢
Titanium hairline
stainless steel



DS-TM12
选配 Optional

玫瑰金发纹不锈钢
Rose gold hairline
stainless steel

地板-天然大理石 FLOOR

地板-高端岩板 FLOOR



DS-DB01
选配 Optional



DS-DB02
选配 Optional



DS-DB03
选配 Optional



DS-DB04
选配 Optional



DS-DB11
选配 Optional



DS-DB12
选配 Optional



DS-DB13
选配 Optional



DS-DB14
选配 Optional

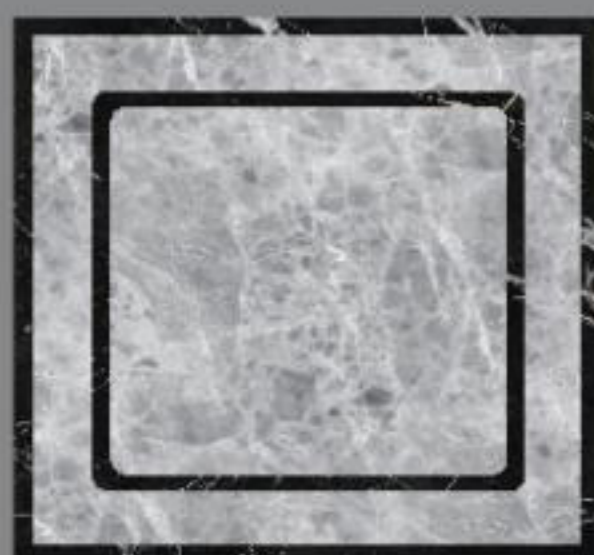

DS-DB05
选配 Optional



DS-DB06
选配 Optional



DS-DB07
选配 Optional



DS-DB08
选配 Optional



DS-DB15
选配 Optional



DS-DB16
选配 Optional



DS-DB17
选配 Optional



DS-DB18
选配 Optional

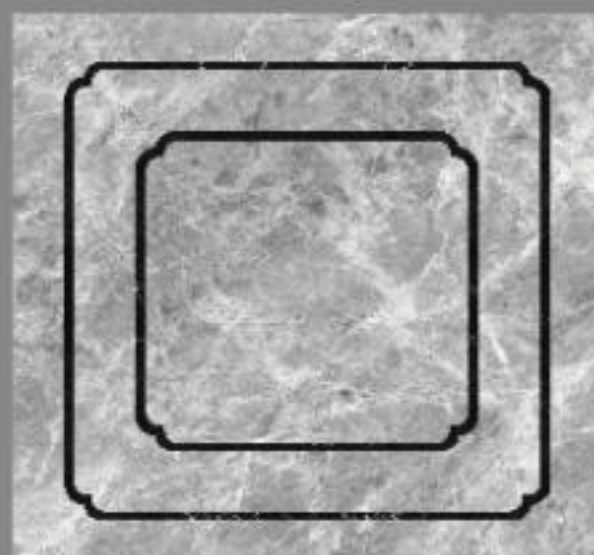

DS-DB09
选配 Optional



DS-DB10
选配 Optional



DS-DB19
选配 Optional



DS-DB20
选配 Optional

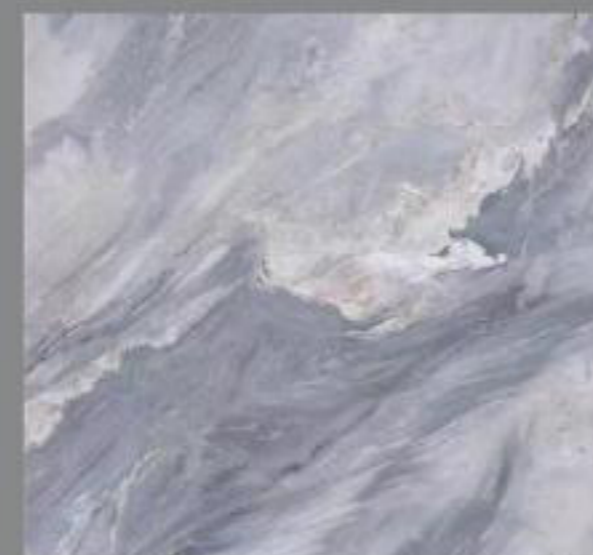

DS-DB21
选配 Optional



DS-DB22
选配 Optional



DS-DB23
选配 Optional



DS-DB24
选配 Optional

扶手 HANDRAIL

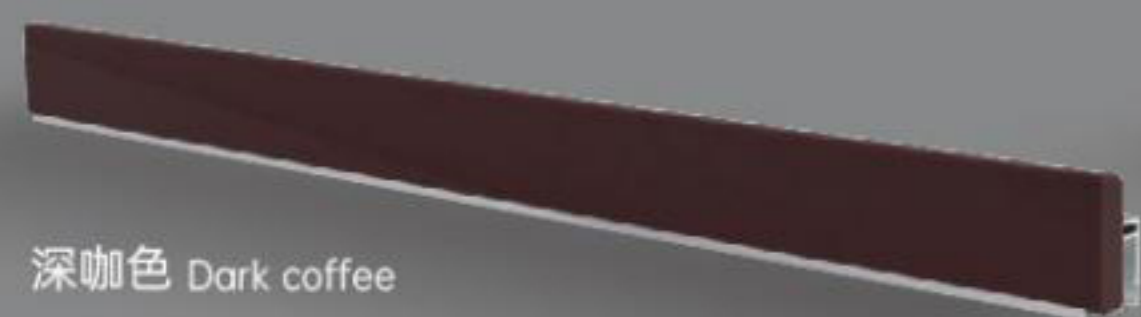

深咖色 Dark coffee



黑色 Black



咖色 Coffee



灰色 Grey

木饰面 WOOD DECORATION



DS-W01
新西兰松木
New zealand pine



DS-W02
新西兰松木
New zealand pine



DS-W03
天鹅绒
Velvet

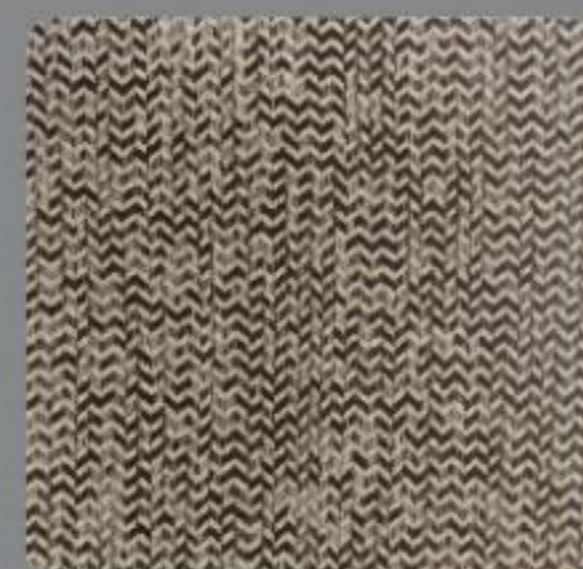

DS-W04
卷柏木
Rolled cypress wood



DS-W05
新西兰松木
New zealand pine



DS-W06
新西兰松木
New zealand pine



DS-W07
意大利黑冰树
Italian black ice tree



DS-W08
新西兰松木
New zealand pine

别墅电梯功能表 VILLA ELEVATOR FUNCTION TABLE

功能名称	Function name
● 电梯变频驱动	● VVVF drive
● 门机变频驱动	● VVVF door operator
● 光幕保护	● Photocell protection
● 超载停梯	● Overload holding stop
● 轿厢风扇/照明节电功能	● Car ventilation, lighting power saving function
● 全集选控制	● Full centralized selection control
● 上电自动开门	● Power on automatic door opening
● 自动关门延时	● Auto close
● 开门保持时间可调	● Door opening holding time adjustable
● 关门错误报警	● Door closing error alarm
● 门联锁保护	● Door interlock protection
● 本层厅外开门	● External door opening of hall on this floor
● 按钮提前关门	● Button to close the door in advance
● 到站自动开门	● Automatic door opening at arrival
● 检修运行	● Maintenance operation
● 停电应急救援装置	● Power failure emergency rescue device
● 轿厢防扒门系统	● Lift car anti stripping door system
● 光幕保护	● Photocell protection
● 定时开关机	● Timing switch
● 楼层指令误删	● Erroneous deletion of floor instruction
○ IC卡控制功能	○ IC card control function
○ 语音安抚功能	○ Voice calm function
○ 智能语音呼梯	○ Intelligent voice call
○ 语音报站	○ Voice announcer
○ 智能灯控	○ Intelligent light control
○ 智能净化系统	○ Intelligent purification system
○ 物联网监控	○ IOT monitoring
○ 安全童锁功能	○ Child safety lock function
○ 到站钟	○ Arrival clock
○ 炫彩灯带	○ Colorful lamp strip

DS200系列标准规格 (曳引对重)

DS200 SERIES SPECIFICATION

PARAMETER TABLE

型号 Model	DS210			DS220			DS230			DS250														
井道形式	混凝土井道																							
开门方式	手拉门			中分门			中分双折门			旁开门														
序号	1	2	3	4	5	6	7	8	9	10	11	12												
载人数 (位)	3~4	4~5	5~6	3~4	4~5	5~6	3~4	4~5	5~6	3~4	4~5	5~6												
轿厢面积 (m ²)	M	L	XL	M	L	XL	M	L	XL	M	L	XL												
	0.7~0.9	0.9~1.2	1.2~1.6	0.7~0.9	0.9~1.2	1.2~1.6	0.7~0.9	0.9~1.2	1.2~1.6	0.7~0.9	0.9~1.2	1.2~1.6												
轿厢净宽 (CW)	1000	1100	1300	1000	1100	1300	1000	1100	1300	1000	1100	1300												
轿厢净深 (CD)	900	1000	1100	900	1000	1100	900	1000	1100	900	1000	1100												
轿厢高度 (CH)	2200																							
开门宽度 (OP)	750	750	750	700	650	700	650	800	800	800	800	800	700	800	750	800								
开门高度 (OPH)	2100																							
主机位置 (ML)	侧顶	后顶	侧顶	后顶	侧顶	后顶	侧顶	后顶	侧顶	后顶	侧顶	后顶	侧顶	后顶	侧顶	后顶	侧顶	后顶	侧顶	后顶	侧顶	后顶		
井道宽度 (HW)	1620	1420	1720	1520	1920	1820	1620	1420	1720	1520	1920	1820	1620	1420	1720	1520	1920	1820	1620	1420	1720	1520	1920	
井道深度 (HD)	1100	1290	1200	1390	1300	1490	1160	1350	1260	1450	1360	1550	1220	1410	1320	1510	1420	1610	1220	1410	1320	1510	1420	1610
底坑深度 (S)	侧置350, 后置250																							
提升高度 (RISE)	不超过21米																							

注: 未注明单位均为mm

DS200G系列标准规格 (曳引对重)

DS200G SERIES SPECIFICATION

PARAMETER TABLE

型号 Model	DS210G			DS220G			DS230G			DS250G														
井道形式	铝合金框架																							
开门方式	手拉门			中分门			中分双折门			旁开门														
序号	1	2	3	4	5	6	7	8	9	10	11	12												
载人数 (位)	3~4	4~5	5~6	3~4	4~5	5~6	3~4	4~5	5~6	3~4	4~5	5~6												
轿厢面积 (m ²)	M	L	XL	M	L	XL	M	L	XL	M	L	XL												
	0.7~0.9	0.9~1.2	1.2~1.6	0.7~0.9	0.9~1.2	1.2~1.6	0.7~0.9	0.9~1.2	1.2~1.6	0.7~0.9	0.9~1.2	1.2~1.6												
轿厢净宽 (CW)	1000	1100	1300	1000	1100	1300	1000	1100	1300	1000	1100	1300												
轿厢净深 (CD)	900	1000	1100	900	1000	1100	900	1000	1100	900	1000	1100												
轿厢高度 (CH)	2200																							
开门宽度 (OP)	750	750	750	700	650	750	700	800	800	800	800	800	700	800	750	800								
开门高度 (OPH)	2100																							
主机位置 (ML)	侧顶	后顶	侧顶	后顶	侧顶	后顶	侧顶	后顶	侧顶	后顶	侧顶	后顶	侧顶	后顶	侧顶	后顶	侧顶	后顶	侧顶	后顶	侧顶	后顶		
框架宽度 (FW)	1690	1470	1790	1570	1990	1770	1690	1490	1790	1590	1990	1790	1690	1490	1790	1590	1990	1790	1690	1490	1790	1590	1990	
框架深度 (FD)	1120	1310	1220	1410	1320	1510	1200	1390	1300	1490	1400	1590	1260	1450	1360	1550	1460	1650	1260	1450	1360	1550	1460	1650
井道宽度 (HW)	1720	1500	1820	1600	2020	1800	1720	1520	1820	1620	2020	1820	1720	1520	1820	1620	2020	1820	1720	1520	1820	1620	2020	1820
井道深度 (HD)	1440	1330	1240	1430	1340	1530	1220	1410	1320	1510	1420	1610	1280	1470	1380	1570	1480	1670	1280	1470	1380	1570	1480	1670
底坑深度 (S)	侧置350, 后置250																							
提升高度 (RISE)	不超过21米																							

注: 未注明单位均为mm

DS300系列标准规格(1:1)

DS300 SERIES SPECIFICATION PARAMETER TABLE

型号 Model	DS310			DS320			DS330			DS350		
井道形式	混凝土井道											
开门方式	手拉门			中分门			中分双折门			旁开门		
序号	1	2	3	4	5	6	7	8	9	10	11	12
载人数 (位)	3~4	4~5	5~6	3~4	4~5	5~6	3~4	4~5	5~6	3~4	4~5	5~6
轿厢面积 (m ²)	M	L	XL	M	L	XL	M	L	XL	M	L	XL
	0.7~0.9	0.9~1.2	1.2~1.6	0.7~0.9	0.9~1.2	1.2~1.6	0.7~0.9	0.9~1.2	1.2~1.6	0.7~0.9	0.9~1.2	1.2~1.6
轿厢净宽 (CW)	1000	1100	1300	1000	1100	1300	1000	1100	1300	1000	1100	1300
轿厢净深 (CD)	900	1000	1100	900	1000	1100	900	1000	1100	900	1000	1100
轿厢高度 (CH)	2200											
开门宽度 (OP)	750	750	750	700	600	750	650	800	750	800	800	800
开门高度 (OPH)	2100											
主机位置 (ML)	侧顶	后顶	侧顶	后顶	侧顶	后顶	侧顶	后顶	侧顶	后顶	侧顶	后顶
井道宽度 (HW)	1620	1370	1720	1470	1920	1670	1620	1370	1720	1470	1920	1670
井道深度 (HD)	1100	1290	1210	1390	1310	1490	1170	1350	1270	1450	1370	1550
底坑深度 (S)	250											
提升高度 (RISE)	不超过21米											

注：未注明单位均为mm

DS300G系列标准规格(1:1)

DS300G SERIES SPECIFICATION PARAMETER TABLE

型号 Model	DS310G			DS320G			DS330G			DS350G		
井道形式	铝合金框架											
开门方式	手拉门			中分门			中分双折门			旁开门		
序号	1	2	3	4	5	6	7	8	9	10	11	12
载人数 (位)	3~4	4~5	5~6	3~4	4~5	5~6	3~4	4~5	5~6	3~4	4~5	5~6
轿厢面积 (m ²)	M	L	XL	M	L	XL	M	L	XL	M	L	XL
	0.7~0.9	0.9~1.2	1.2~1.6	0.7~0.9	0.9~1.2	1.2~1.6	0.7~0.9	0.9~1.2	1.2~1.6	0.7~0.9	0.9~1.2	1.2~1.6
轿厢净宽 (CW)	1000	1100	1300	1000	1100	1300	1000	1100	1300	1000	1100	1300
轿厢净深 (CD)	900	1000	1100	900	1000	1100	900	1000	1100	900	1000	1100
轿厢高度 (CH)	2200											
开门宽度 (OP)	750	750	750	700	600	750	650	800	750	800	800	800
开门高度 (OPH)	2100											
主机位置 (ML)	侧顶	后顶	侧顶	后顶	侧顶	后顶	侧顶	后顶	侧顶	后顶	侧顶	后顶
框架宽度 (FW)	1690	1440	1790	1540	1990	1740	1690	1440	1790	1540	1990	1740
框架深度 (FD)	1110	1310	1210	1410	1310	1510	1210	1390	1310	1490	1410	1590
井道宽度 (HW)	1720	1470	1820	1570	2020	1770	1720	1470	1820	1570	2020	1770
井道深度 (HD)	1130	1330	1230	1430	1330	1530	1230	1410	1330	1510	1430	1610
底坑深度 (S)	250											
提升高度 (RISE)	不超过21米											

注：未注明单位均为mm

DS300/DS300G系列标准规格(2:1)

DS300/DS300G SERIES SPECIFICATION PARAMETER TABLE

型号 Model	DS 310	DS 310G	DS 310	DS 310G	DS 310	DS 310G	DS 320	DS 320G	DS 320	DS 320G	DS 320	DS 320G	DS 330	DS 330G	DS 330	DS 330G	DS 330	DS 330G	DS 350	DS 350G	DS 350	DS 350G		
井道形式	混凝土井道&铝合金框架																							
开门方式	手拉门			中分门			中分双折门			旁开门														
序号	1	2	3	4	5	6	7	8	9	10	11	12												
载人数 (位)	3~4	4~5	5~6	3~4	4~5	5~6	3~4	4~5	5~6	3~4	4~5	5~6												
轿厢面积 (m²)	M	L	XL	M	L	XL	M	L	XL	M	L	XL												
	0.7~0.9	0.9~1.2	1.2~1.6	0.7~0.9	0.9~1.2	1.2~1.6	0.7~0.9	0.9~1.2	1.2~1.6	0.7~0.9	0.9~1.2	1.2~1.6												
轿厢净宽 (CW)	1000	1100	1300	1000	1100	1300	1000	1100	1300	1000	1100	1300												
轿厢净深 (CD)	900	1000	1100	900	1000	1100	900	1000	1100	900	1000	1100												
轿厢高度 (CH)	2200																							
开门宽度 (OP)	750	750	750	700	750	800	800	800	800	800	800	800												
开门高度 (OPH)	2100																							
主机位置 (ML)	侧顶	后顶	侧顶	后顶	侧顶	后顶	侧顶	后顶	侧顶	后顶	侧顶	后顶	侧顶	后顶	侧顶	后顶	侧顶	后顶	侧顶	后顶	侧顶	后顶		
框架宽度 (FW)	/	1670	/	1770	/	1970	/	1670	/	1770	/	1970	/	1670	/	1770	/	1970	/	1670	/	1770	/	1970
框架深度 (FD)	/	1100	/	1200	/	1300	/	1190	/	1290	/	1390	/	1250	/	1350	/	1450	/	1250	/	1350	/	1450
井道宽度 (HW)	1620	1700	1720	1800	1920	2000	1620	1700	1720	1800	1920	2000	1620	1700	1720	1800	1920	2000	1620	1700	1720	1800	1920	2000
井道深度 (HD)	1090	1120	1190	1220	1290	1320	1150	1210	1250	1310	1350	1410	1210	1270	1310	1370	1410	1470	1210	1270	1310	1370	1410	1470
底坑深度 (S)	350																							
提升高度 (RISE)	不超过21米																							

注: 未注明单位均为mm

DS1000系列标准规格

DS1000 SERIES SPECIFICATION PARAMETER TABLE

型号 Model	DS1010						DS1020						DS1030						DS1050								
井道形式	铝合金框架																										
开门方式	手拉门						中分门						中分双折门						旁开门								
序号	1	2	3	4	5	6	7	8	9	10	11	12															
载人数 (位)	3~4	4~5	5~6	3~4	4~5	5~6	3~4	4~5	5~6	3~4	4~5	5~6															
轿厢面积 (m²)	M	L	XL	M	L	XL	M	L	XL	M	L	XL															
	0.7~0.9	0.9~1.2	1.2~1.6	0.7~0.9	0.9~1.2	1.2~1.6	0.7~0.9	0.9~1.2	1.2~1.6	0.7~0.9	0.9~1.2	1.2~1.6															
轿厢净宽 (CW)	1000	1100	1200	1000	1100	1200	1000	1100	1200	1000	1100	1200															
轿厢净深 (CD)	1000	1100	1200	1000	1100	1200	1000	1100	1200	1000	1100	1200															
轿厢高度 (CH)	2200																										
开门宽度 (OP)	700	750	750	600	650	600	700	650	700	650	800	750	800	700	750	650	800	750									
开门高度 (OPH)	2100																										
主机位置 (ML)	侧顶	后顶	侧顶	后顶	侧顶	后顶	侧顶	后顶	侧顶	后顶	侧顶	后顶	侧顶	后顶	侧顶	后顶	侧顶	后顶	侧顶	后顶	侧顶	后顶	侧顶	后顶			
框架宽度 (FW)	1440	1260	1540	1360	1640	1460	1440	1540	1400	1640	1500	1440	1260	1540	1360	1640	1460	1440	1540	1360	1640	1460	1440	1540	1360	1640	1460
框架深度 (FD)	1210	1380	1310	1480	1410	1580	1300	1400	1570	1500	1670	1360	1530	1460	1630	1560	1730	1360	1460	1630	1560	1730	1360	1460	1630	1560	1730
井道宽度 (HW)	1470	1290	1570	1390	1670	1490	1470	1570	1430	1670	1530	1470	1290	1570	1390	1670	1490	1470	1570	1390	1670	1490	1470	1570	1390	1670	1490
井道深度 (HD)	1230	1400	1330	1500	1430	1600	1320	1420	1590	1520	1690	1380	1550	1480	1650	1580	1750	1380	1480	1650	1580	1750	1380	1480	1650	1580	1750
底坑深度 (S)	250																										
提升高度 (RISE)	不超过21米																										

注: 未注明单位均为mm



专业服务，挚诚为您
PROFESSIONAL SERVICES
TO YOU WHOLEHEARTEDLY

服务的核心不只是结果还有过程，我们注重的不是产品的售出而是客户满意的体验。

The core of services is not only results but also processes. We attach importance to customer satisfaction rather than the sale of products.

全天候

我们提供全天候的卓越服务，并在售前、售中、售后一以贯之，将全心全意的行动落实于品牌服务的每一步。

All-weather

We provide all-weather excellent services. Moreover, we offer brand services wholeheartedly during pre-sales, sales and after-sales processes.

管家级

我们制定了健全的用户管理和维保技术提升制度，以覆盖全国范围的维保网络，为您提供管家级的专业服务。

Butler-level

We have customized a sound system for the management of users and the improvement of maintenance technologies. With a nationwide maintenance network, we provide butler-level professional services.

24h守候

特设24小时在线服务，专业的客服人员随时响应您咨询和求助。

Around-the-clock services

We offer around-the-clock online services. Our professional customer service personnel respond to your inquires and requests.

超高效

我们通过物联网服务中心与独立的电梯档案，快速为您的电梯制定针对性维保方案，并在使用过程中高效、贴心的进行维保。

Highly efficient

Through the IoT service center and the independent lift archives, we rapidly customize targeted solutions to lift maintenance and offer efficient good maintenance services in the use of lifts.